

Holley HIGH PERFORMANCE**TABLE OF CONTENTS**

Alphabetical Components Listing	Page
Accelerator Pumps/Components	1
Accelerator Pump Arms/Components	2
Accelerator Pump Cams/Components	3
Accelerator Pump Nozzles/Components	4
Base Plates	5
Base Plates/Throttle Plates	6
Base Plate Components	7
Boosters/Tools	8
Chokes/Components	9
Choke Components	10
Choke Conversion Kits	11
Float Bowls	12
Float Bowls/Hardware	13
Float Bowl Hardware	14
Floats/Components	15
Gaskets-Air Cleaner, Air Horn, Fuel Bowl	16
Gaskets-Flange	17
Gaskets-Metering Block	18
Gaskets-Throttle Body	19
Jets & Bleeds	20
Main Bodies	21-22
Metering Blocks	23
Metering Block Components	24
Needle & Seat/Components	25
Power Valves/Components	26
Secondary Diaphragms/Components	27
Secondary Diaphragm Components	28
Throttle Shafts	29
Throttle Shaft Components	30
Throttle Linkage/Components	31
Miscellaneous	32-33

ACE
Fuel Systems

(800) 325-3888 • (620) 429-1000
206 N. Kansas Ave. • P.O. Box 151 • Columbus, KS 66725

ACE Fuel Systems takes extensive measures to ensure the accuracy of descriptions and applications for each part represented in this publication. The sole intent of this catalog is to aid ACE customers in the rebuilding of automotive aftermarket products. ACE assumes no responsibility for possible errors. Permission to reproduce any portion of this publication is denied.

Holley® HIGH PERFORMANCE

HOLLEY PART No. TO PAGE NUMBER INDEX

HOLLEY #	PAGE	HOLLEY #	PAGE	HOLLEY #	PAGE	HOLLEY #	PAGE
6-500.....	25	26-116.....	14	125-25 thru 125-95 ..	26	1007-38.....	32
6-502.....	25	34-9.....	8	125-145.....	26	1007-107.....	24, 32
6-504.....	25	34-25.....	12	125-165.....	26	1007-122.....	24
6-506.....	25	34-26.....	12	125-500.....	26	1007-129.....	24, 32
6-513.....	25	34-32.....	8	134-9.....	23	1007-275.....	20
6-515.....	25	34-36.....	8	134-21.....	23	1007-435.....	32
6-518.....	25	45-223.....	11	134-101.....	12	1007-556.....	32
6-519.....	25	45-224.....	11	134-102.....	12	1007-557.....	32
9-16.....	9	45-225.....	11	134-103.....	12	1007-640.....	20, 24
9-118.....	9	45-230.....	9	134-104.....	12	1007-641.....	20, 24
18-9.....	27	45-258.....	9	134-105.....	12	1007-654-54.....	20, 24
20-3.....	29	45-376.....	9	134-106.....	12	1008-669.....	26
20-13.....	28	45-456.....	28	134-108.....	12	1008-776.....	25
20-20.....	30	108-2.....	14	134-112.....	12	1008-777.....	25
20-48-1.....	29	108-3.....	19	134-128.....	23	1008-844.....	4
20-49-1.....	29	108-4.....	13	134-131.....	23	1008-1265.....	19
20-53.....	31	108-5.....	19	134-137.....	23	1008-1436.....	17
20-54.....	31	108-7.....	19	134-175.....	23	1008-1448.....	19
20-55.....	31	108-8.....	14	134-200.....	23	1008-1597.....	26
20-59.....	28	108-9.....	17	134-211.....	23	1008-1735.....	19
20-65.....	31	108-10.....	17	134-213.....	23	1008-1828.....	4
20-78.....	2	108-11.....	14	134-227.....	23	1008-1848.....	18
20-80.....	3	108-13.....	18	134-228.....	23	1008-2086.....	4
20-81.....	3	108-17.....	17	134-254.....	23	1009-96.....	6
20-85.....	27	108-27.....	18	135-2.....	27	1009-103.....	6
20-86.....	27	108-29.....	18	135-3.....	27	1009-107.....	6
20-87.....	27	108-30.....	18	135-4.....	27	1009-109.....	6
26-2.....	14	108-31.....	18	135-5.....	1	1009-172.....	6
26-3.....	14	108-32.....	16	135-6.....	27	1009-180.....	6
26-4.....	1	108-33.....	16	135-7.....	1	1009-215.....	6
26-5.....	1	108-36.....	18	135-9.....	1	1009-228.....	6
26-6.....	14	108-40.....	19	135-10.....	1	1009-267.....	6
26-7.....	7	108-55.....	18	1002-388.....	10	1009-311.....	6
26-8.....	14	108-56.....	13	1002-531.....	10	1009-326.....	6
26-12.....	4	108-57.....	19	1003-278.....	10	1009-327.....	6
26-13.....	13	108-61.....	19	1004-524.....	10	1009-328.....	6
26-18.....	14	108-63.....	16	1004-485.....	30	1009-342.....	6
26-23.....	1	108-64.....	16	1004-1287.....	30	1009-344.....	6
26-24.....	14	108-66.....	26	1005-4.....	10	1009-354.....	6
26-25.....	14	108-67.....	9, 28	1005-159.....	24	1011-1413.....	30
26-26.....	14	108-68.....	26	1005-372.....	7	1011-2583.....	30
26-27.....	14	108-71.....	16	1005-569.....	9	1013-490.....	30
26-29.....	14	108-73.....	16	1005-581.....	6, 7	1013-513.....	30
26-36.....	26	108-77.....	13	1005-584.....	3, 27, 30	1013-590.....	30
26-37.....	14	108-97.....	14	1005-623.....	9	1013-599.....	30
26-38.....	1	108-98.....	14	1005-635.....	6, 7	1013-600.....	30
26-39.....	13	112-2.....	5	1005-682.....	3	1013-1469.....	30
26-41.....	1	112-9.....	5	1005-765.....	25	1014-744-70.....	32
26-42.....	14	112-96.....	5	1005-854.....	4	1014-782A.....	24
26-43.....	14	112-97.....	5	1005-691.....	24	1014-797.....	32
26-65.....	27	116-1.....	15	1005-1016.....	15	1014-798.....	8
26-66.....	27	116-2.....	15	1005-1258.....	30	1014-1289.....	32
26-68.....	20	116-3.....	15	1005-1260.....	6, 7	1014-1293A.....	24
26-85.....	13	116-4.....	15	1005-1271.....	7	1015-40.....	24
26-102.....	14	121-25 thru 121-45 ..	4	1005-1601.....	7	1015-120.....	24
26-110.....	24	121-125 thru 121-152 .	4	1005-2043.....	30	1015-213.....	7
26-113.....	13	121-225 thru 121-240 .	4	1005-2050.....	7	1017-41.....	15
26-114.....	14	122-60 thru 122-100 .	20	1007-20.....	24, 32	1018-252.....	25
26-115.....	14	122-5000.....	20	1007-23.....	32	1021-572-21.....	4

Holley® HIGH PERFORMANCE

HOLLEY #	PAGE	HOLLEY #	PAGE	HOLLEY #	PAGE	HOLLEY #	PAGE
1021-718	8	1038-569	1	1041-290	3	1059-37A	24
1023-258	4	1038-583	30	1041-330	3	1059-79	15
1023-556	13	1038-757	15	1041-336	3	1059-96	13
1027-152	24	1038-803	15	1041-427	3	1059-97	13
1033-538	31	1038-1216	15	1041-466	3	1059-171	24
1033-545	31	1038-1375	1	1041-664	3	1063-311	1
1034-2183	1	1038-1490	1	1041-931	9	1063-441	1
1034-2774	1	1038-1500	30	1041-935	9	1063-740	2
1034-10918	13	1038-1559	7	1043-203	31	1063-741	2
1035-747	27	1038-1762	30	1043-252	31	1063-822	3
1036-164	27	1039-160	25	1043-500	31	1063-833	2
1036-574	2, 7	1041-218	3	1043-983	31	1063-853	2
1037-133	2, 7, 31	1041-234	3	1046-395	31	1075-37	2, 7, 31
1038-110	7	1041-240	3	1048-183	31		

ACE PART No. TO PAGE NUMBER INDEX

ACE #	PAGE	ACE #	PAGE	ACE #	PAGE	ACE #	PAGE
5-146	24, 32	20-1564	19	25-463A	25	150-31	31
5-231	24, 32	20-1634	19	25-463AX	25	156-97	14
5-232	24	20-1637	17	25-480A	25	169-13	1
5-246	11	20-1638	17	25-611A	25	H2-11	13
5-257	13	20-1639	19	25-634A	25	H2-24	28
8-144A	26	20-1640	19	25-976A	25	H2-25	27
8-145A	26	20-1662	14	25-990A	25	H2-26	32
8-146A	26	20-1899	16	28-37	24	H3-48	30
8-147A	26	20-1983	13	36-33	30	H3-49	29
8-148A	26	20-1990	19	36-34	30	H3-50	29
8-149A	26	20-2053	26	36-35	30	H3-52	29
8-150A	26	20-2198	19	36-36	30	H3-53	29
8-151A	26	20-2254	18	39-19	10	H3-55	29
8-159A	26	20-2255	16	39-134A	11, 28	H3-56	29
10-2107	9	20-2257	17	39-136	6, 7	H3-58	29
10-2297	9	20-2305	26	39-168	25	H3-64	29
17-214	4	20-2306	19	48-26	4	H3-65	29
20-75	14	20-2464	18	48-27	4	H5-45	14
20-82X	4	20-2465	18	48-28	4	H5-46	14
20-192	13	20-2466	16	48-29	4	H5-64	1, 7, 31
20-337	14	20-2467	18	61-185	11	H5-75	1
20-413	9, 11, 28	20-2613	19	61-498	7	H5-76	1
20-416	9	20-2624	18	61-604	28	H5-77	24
20-421	24	20-2798	13	61-605	28	H5-79	7
20-422	14	20-2820	18	61-606	28	H5-80	27
20-492	9	20-2899	9	61-607	28	H5-81	9, 11
20-528	25	20-2903	14	61-608	28	H5-82	3, 27, 30
20-529	25	20-2910	16	61-609	28	H5-83	9, 11
20-607	13	20-2926	16	61-610	28	H5-84	6, 7
20-620	4	20-2973	18	63-97	1, 7, 31	H5-85	3
20-676	14	20-2975	18	63-99	27	H5-86	4
20-950	13	20-3023	16	63-159	2, 7	H5-87	15
20-1094	17	20-3277	16	63-244	11	H5-88	4
20-1095	19	20-3278	16	64-315A	27	H5-89	6, 7
20-1224	19	20-3279	4	64-600A	27	H5-90	14
20-1229	17	20-3280	26	64-707A	27	H5-91	13
20-1254	14	20-3281	26	64-744A	27	H5-92	26
20-1410	19	20-3344	4	64-798A	1	H5-94	7
20-1417	18	20-4207	4	64-916A	1	H5-96	13
20-1423	18	21-726A	15	64-1625A	1	H5-99	7
20-1433	9, 11	21-729A	15	64-1642A	1	H5-100	7
20-1451	14	21-742A	15	105-20	25	H5-103	30
20-1479	1	21-756A	15	116-25	26	H5-107	11
20-1493	19	21-757A	15	145-18	32	H5-108	11

Holley® HIGH PERFORMANCE

ACE PART No. TO PAGE NUMBER INDEX















ACE #	PAGE	ACE #	PAGE	ACE #	PAGE	ACE #	PAGE
H5-109	24	H20-276	16	H25-93	22	H63-60	27
H5-110	7	H20-277	18	H25-94	21	H63-62	30
H5-111	30	H20-278	28	H25-96	23	H63-65	30
H5-112	7	H20-283	17	H25-97	6	H64-13	27
H5-113	7	H20-284	17	H25-98	21	H108-38	14
H10-47	30	H20-286	19	H25-99	22	H108-39	31
H10-104	20, 24	H20-287	14	H25-100	23	H108-40	28
H10-106	20, 24	H20-288	16	H25-101	24	H115-253	31
H10-107	20, 32	H20-289	18	H25-103	22	H115-254	31
H10-109	20, 24	H20-290	18	H25-104	4	H115-374	31
H10-110	20	H20-291	16	H25-105	23	H115-375	31
H10-111	11	H20-292	24	H25-108	13	H115-376	31
H10-114	20	H21-30	15	H25-109	13	H115-377	31
H10-115	30	H24-50	15	H25-111	6	H115-380	31
H10-121	20	H24-51	7	H25-112	23	H115-382	31
H12-64	10	H24-56	1	H25-113	22	H115-383	31
H14-33	11	H25-31	6	H25-114	6	H115-386	31
H14-36	10	H25-32	5	H25-115	6	H115-389	11
H15-64	14	H25-34	25	H28-109	7	H115-397	31
H15-86	14	H25-36	25	H28-110	24	H118-22	12
H15-87	14	H25-37	25	H28-111	24	H118-23	12
H15-88	14	H25-38	25	H30-21	13	H118-24	12
H15-89	14	H25-39	25	H47-44	26	H118-25	1
H17-54	9	H25-40	23	H47-45	32	H118-26	1
H17-55	9	H25-42	24	H47-46	32	H118-27	12
H17-56	9	H25-44	15	H47-47	24, 32	H118-28	12
H17-60	11, 30	H25-45	6	H47-48	24, 32	H118-29	12
H17-61	11, 30	H25-47	5	H47-50	32	H118-30	28
H17-62	11	H25-48	5	H61-82	15	H118-33	12
H19-5	8	H25-50	23	H61-125	11	H118-34	12
H19-6	8	H25-54	21	H61-147	26	H118-35	12
H19-7	8	H25-55	21	H61-148	1	H118-36	12
H19-8	8	H25-56	21	H61-150	15	H118-38	13
H19-9	8	H25-57	22	H61-151	1	H122-4	26
H19-10	8	H25-58	27	H61-152	15	H145-2	14
H19-11	8	H25-59	11, 28	H61-153	1	H145-59	1
H19-12	8	H25-60	11, 28	H61-154	30	H145-248	14
H19-14 thru H19-29	4	H25-63	25	H61-155	11, 30	H145-251	8
H19-30	8	H25-64	25	H61-157	30	H145-252	32
H19-32	8	H25-65	22	H61-158	7	H145-253	7
H19-33	8	H25-66	22	H63-14	3	H145-254	7, 24
H19-35	8	H25-69	23	H63-25	3	H145-257	14
H19-36	4	H25-70	23	H63-40	3	H145-259	32
H19-39	8	H25-73	5	H63-41	3	H145-260	24
H19-40	8	H25-74	23	H63-42	3	H145-261	32
H19-42	8	H25-75	23	H63-43	3	H145-262	32
H19-45	8	H25-76	23	H63-44	3	H145-263	32
H19-46	8	H25-77	23	H63-45	3	H145-264	8
H19-47	4	H25-78	23	H63-46	3	H145-265	32
H19-48	4	H25-79	23	H63-47	3	H145-266	32
H19-52	8	H25-80	25	H63-48	3	H145-267	24
H19-53	8	H25-81	22	H63-49	2	H145-268	24
H19-54	8	H25-82	22	H63-50	2	H145-269	14
H20-265	16	H25-83	11	H63-51	3	H145-270	14
H20-268	17	H25-87	11	H63-52	2	H145-271	14
H20-270	13	H25-88	11	H63-54	2	H150-78	28
H20-271	19	H25-89	11	H63-57	1	H151-60 thru H151-100	20
H20-272	19	H25-90	11	H63-58	1	H160-25 thru H160-95	26
H20-273	19	H25-92	23	H63-59	2	H160-145	26

Holley® HIGH PERFORMANCE

ACE PART No. TO PAGE NUMBER INDEX

ACE #	PAGE	ACE #	PAGE	ACE #	PAGE	ACE #	PAGE
H160-165	26	H186-63	6	H186-77	6	RT-23	9
H170-113	9, 11	H186-64	6	H186-79	6	RT-24	9
H170-114	9	H186-65	6	H186-80	6	RT-25	17
H186-55	6	H186-67	6	H204-25	11	RT-35	8
H186-56	6	H186-68	6	HC4-12	14	SP-25	14
H186-57	6	H186-69	32	HC11-12	14	T146-5	11
H186-58	6	H186-71	10	R20-35P	14	U2-19	11
H186-59	6	H186-73	10	R146-2	11		
H186-60	6	H186-75	24	RT-20	26		
H186-62	6	H186-76	6	RT-21	26		

ACCELERATOR PUMPS / COMPONENTS

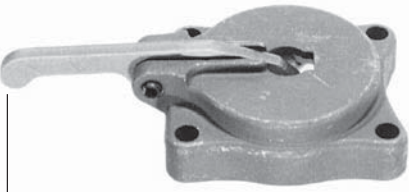
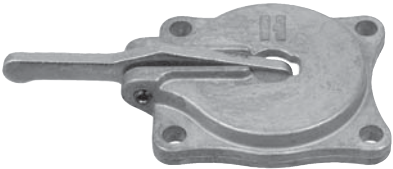
 <p>Accelerator Pump Check Valve</p> <p>169-13 (26-41)</p>	 <p>Pump Inlet Check Ball Retainer</p> <p>H24-56</p>	 <p>Transfer Tube O-Ring</p> <p>20-1479 (26-38)</p>	 <p>Accelerator Pump Transfer Tube</p> <p>H145-59 (26-23)</p>	 <p>Pump Diaphragm Return Spring (50cc)</p> <p>H61-151 (1038-1490)</p>
 <p>Pump Diaphragm Return Spring (Light - 30cc)</p> <p>H61-153 (1038-1375)</p>	 <p>Pump Diaphragm Return Spring (Heavy - 30cc)</p> <p>H61-148 (1038-569)</p>	 <p>Pump Cover Screw (30cc) (8-32 x 27/64" L)</p> <p>H5-75 (26-4)</p>	 <p>Pump Cover Screw (50cc) (8-32 x 35/64" L)</p> <p>H5-76 (26-5)</p>	
 <p>Accelerator Pump (50cc)</p> <p>64-798A – BUNA (135-7) 64-1642A – GFLT (alcohol resistant) (135-9)</p>	 <p>Accelerator Pump (30cc)</p> <p>64-916A – BUNA (135-5) 64-1625A – GFLT (alcohol resistant) (135-10)</p>	 <p>Pump Cover Arm (50cc)</p> <p>H63-58 (1063-441)</p>	 <p>Pump Cover Arm (30cc)</p> <p>H63-57 (1063-311)</p>	
 <p>Pump Arm Roll Pin (1/8" x 1/2"L)</p> <p>H24-57</p>	 <p>Pump Cover Assembly (50cc)</p> <p>H118-26 (1034-2774)</p>	 <p>Pump Cover Assembly (30cc)</p> <p>H118-25 (1034-2183)</p>		

Holley® HIGH PERFORMANCE

ACCELERATOR PUMP ARMS / COMPONENTS



Pump Arm Clip
(early style)
63-159
(1036-574)



Pump Arm Retaining Clip
(1/4" Dia.)
63-97
(1075-37)



Pump Arm Stud
H5-64
(1037-133)



Steel Pump Arm
(30 cc)
H63-49
(1063-740)



Pump Arm Assembly
(30 cc)
H63-50
(1063-741)



Plastic Pump Arm Assembly
(30 cc)
H63-54 Models 2300, 4150/60
(20-78)



4150 Pump Arm
Assembly
(50 cc)
H63-52
(1063-833)



4500 Pump Arm
Assembly
H63-59
(1063-853)

Holley® HIGH PERFORMANCE

ACCELERATOR PUMP CAMS / COMPONENTS



White Pump Cam
(4150)
H63-14
(1041-218)



Blue Pump Cam
H63-25
(1041-427)



Green Pump Cam
H63-40
(1041-290)



Wide Brown Pump Cam
H63-41
(1041-664)



Black Pump Cam
H63-42
(1041-234)



Red Pump Cam
H63-43
(1041-240)



Pink Pump Cam
H63-44
(1041-330)



Narrow Brown Pump Cam
H63-45
(1041-336)



Orange Pump Cam
H63-46
(1041-466)



White Pump Cam
(4500)
H63-47
(20-80)



Yellow Pump Cam
(4500)
H63-48
(20-81)



Wide Purple
Pump Cam
H63-66



Pump Cam Screw
H5-85
(1005-682)



Secondary Pump
Cam Lever Screw
attaches pump cam
lever to throttle shaft
(10-32 x 5/16" L)
H5-82
(1005-584)

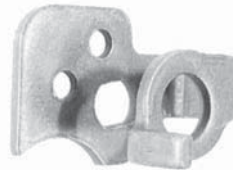

Secondary Pump Cam Lever
H63-51
(1063-822)



Adj. Sec. Pump
Cam Lever
H63-67

Holley® HIGH PERFORMANCE

ACCELERATOR PUMP NOZZLES / COMPONENTS



Pump Check Needle
17-214
(1023-258)



Pump Check Needle Seat
H25-104



Pump Discharge Screw (Standard)
H5-86
(1005-854)



Pump Discharge Screw (Hi-Flow)
H5-88
(26-12)



Pump Nozzle Gaskets
20-82X rubber (.018 thk.)
20-620 fiber (.015 thk.)
(1008-844,1828)



Pump Nozzle Bar Gasket
(4010/4011)
20-3279



Pump Nozzle Bar Gasket
(4011)
20-3344



Pump Nozzle Bar Gasket
(4010/4011 Marine)
20-4207
(1008-2086)



STRAIGHT TYPE

ACE P/N	O.E. P/N	ORIFICE
H19-36	1021-572-21	.021
48-26	121-125	.025
48-27	121-128	.028
48-28	121-131	.031
H19-14	121-132	.032
H19-15	121-135	.035
H19-16	121-137	.037
H19-17	121-140	.040
H19-18	121-142	.042
H19-19	121-145	.045
H19-20	121-147	.047



TUBE TYPE

ACE P/N	O.E. P/N	ORIFICE
H19-23	121-25	.025
48-29	121-28	.028
H19-24	121-31	.031
H19-25	121-35	.035
H19-27	121-40	.040
H19-28	121-42	.042
H19-29	121-45	.045



ANTI - PULLOVER TYPE

ACE P/N	O.E. P/N	ORIFICE
H19-47	121-225	.025
H19-48	121-228	.028

Holley® HIGH PERFORMANCE

BASE PLATES

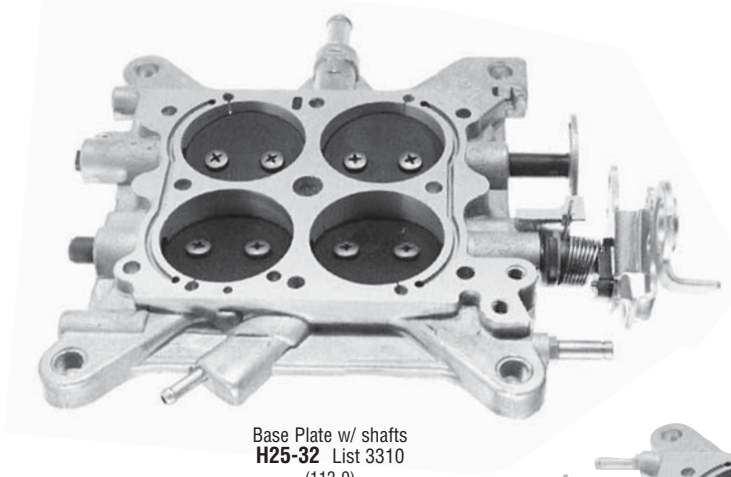

Base Plate w/ shafts
H25-32 List 3310
(112-9)

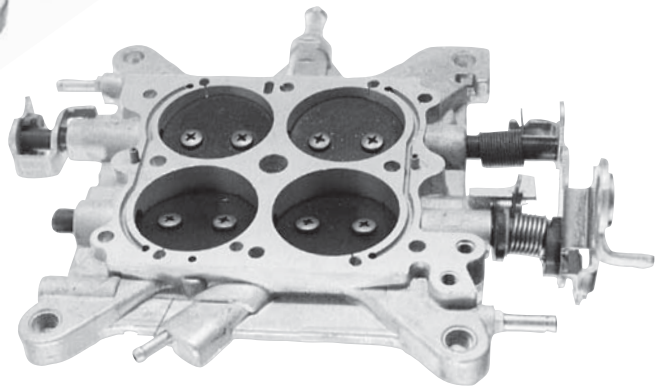

Base Plate w/ shafts
(List 4779)
H25-73 Four-Corner Idle
(112-96)

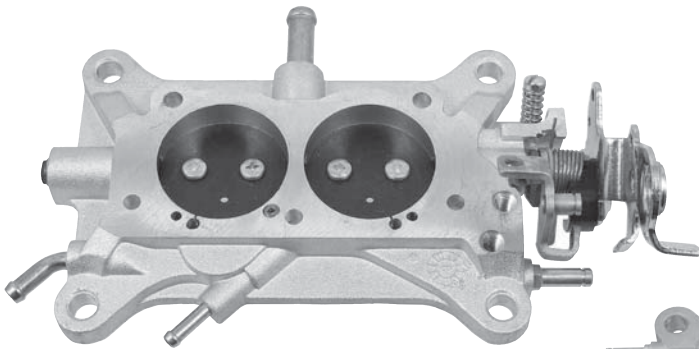

Base Plate w/ shafts
(List 4412)
H25-47
(112-2)

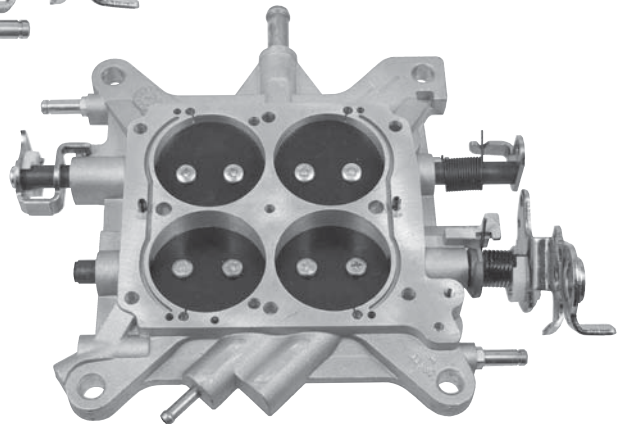

Base Plate w/ shafts
(List 4781)
H25-48 Four-Corner Idle
(112-97)

Holley® HIGH PERFORMANCE

BASE PLATES / THROTTLE PLATES

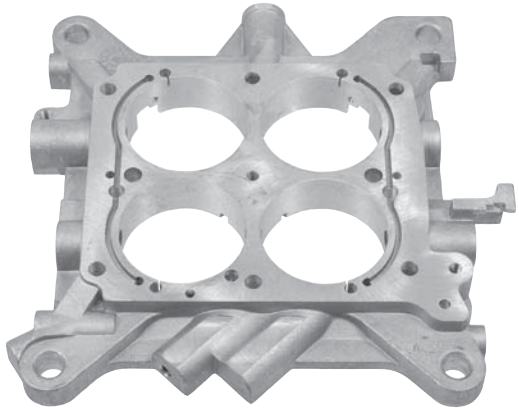

Base Plate w/o shafts
(Four Corner Idle)
H25-31 List 4776
H25-45 List 4777, 4778,
4779, 4780

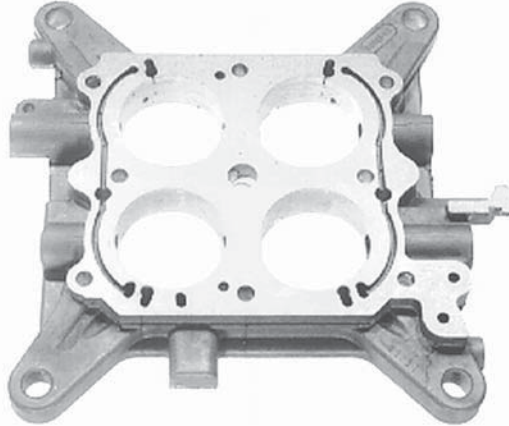

Base Plate w/o shafts
H25-97 390 HP
H25-114 830 HP
H25-115 950/1000 HP
H25-116 650/750 HP

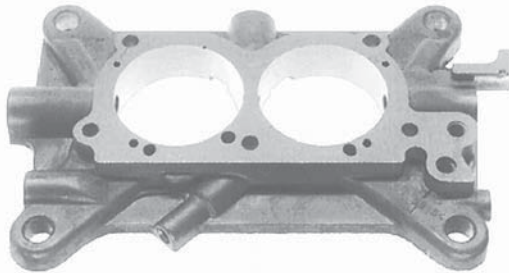
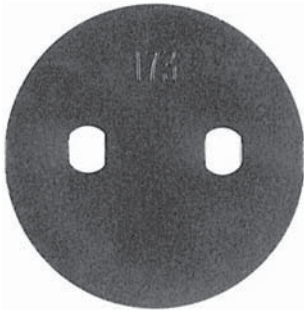

Base Plate w/o shafts
H25-111 350/List 7448
H25-125 500/List 4412

THROTTLE PLATES

ACE P/N	HOLLEY P/N	SIZE	STAMPED
H186-56	1009-96	1-7/16" Primary	96
H186-57	1009-103	1-7/16" Secondary	103
H186-76	1009-327	1-7/16" Primary 390 HP w/.152 Bypass	327
H186-77	1009-328	1-7/16" Secondary 390 HP w/.152 Bypass	328
H186-58	1009-107	1-1/2"	107
H186-59	1009-109	1-9/16"	109
H186-67	1009-267	1-9/16"	267
H186-68	1009-268	1-9/16" Brass	268
H186-65	1009-344	1-9/16" Stainless	344
H186-60	1009-172	1-11/16" Thin	172
H186-63	1009-215	1-11/16" w/.093 Bypass	215
H186-79	1009-354	1-11/16" Stainless	354
H186-82	1009-329	1-11/16" Stainless - w/.150 Bypass	329
H186-62	1009-180	1-3/4"	180
H186-64	1009-326	1-3/4" Stainless	326
H186-55	1009-228	2.00"	228
H186-80	1009-342	2-1/8"	342

Holley® HIGH PERFORMANCE

BASE PLATE COMPONENTS



Throttle Stop Screw Spring

61-498
(1038-110)
H61-158 Model 4500
(1038-1559)



Throttle Stop Screw

H5-94 (1.00" L)
(1005-1271)
H5-100 (1.090" L)
Model 4500
(1005-372)



Pump Arm Stud Retainer
(1/4" Dia.)

63-97
(1075-37)



Pump Arm Stud
(1/4" Dia.)

H5-64
(1037-133)



Pump Arm Clip Retainer
(early style)

63-159
(1036-574)



Secondary Throttle Return Spring Pin

H24-51



Base Plate Alignment Pin
(1/8" x 7/16" L)

H24-58



Throttle Body Screw
(12-24 x 13/16" L)

H5-79
(26-7)



Vacuum Tube
(3/8" O.D. x 11/2" L)

H145-253



Vacuum Tube
(3/16" O.D. x 1.00 L)

H145-254



Idle Mixture Screw
(6-32 x .950L)
(Model 4180)
{Mustang / Ford Trk.}

H28-109
(1015-213)
(MTCFT CM-3853)



Throttle Plate Screw
(8-32 x 31/64" L)

39-136
(1005-581)



Throttle Plate Screw
(8-32 x 5/16" L)

H5-84 O.E. w/ "H"
H5-110 Non-O.E.
(1005-635)



Stainless Steel Throttle Plate Screw
(8-32)

H5-112 1/8" L
H5-113 3/16" L



Throttle Plate Screw-4500
(8-32 x 1/4" L)

H5-89
(1005-1260)



Secondary Throttle Adjusting Screw
(M5 x .8 x 3/8" L)

H5-99
(1005-1601)

Holley® HIGH PERFORMANCE

BOOSTERS / TOOLS

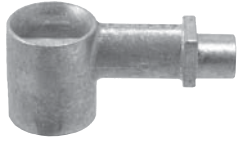

Straight Leg Booster
H19-5 .125 orifice
H19-35 .135 orifice
 (List 7448)
H19-32 .144 orifice
H19-56 Raw Casting
 (drill to size)



Straight Leg w/ Small
 Skirt Booster
 (.140 orifice)
H19-33



Down (Dog) Leg Booster
H19-6 .140 orifice
H19-7 .160 orifice
H19-8 .180 orifice



Double-Step Down (Dog)
 Leg Booster
H19-39 .160 orifice
H19-53 .170 orifice
H19-46 .180 orifice



Annular Booster Banjo
H19-9



Annular Booster Insert
H19-42 Silver/.500 I.D.
H19-10 Silver/.600 I.D.
H19-12 Gold/.600 I.D.



4500 Tall Annular Booster
H19-40 raw casting
 (34-32)

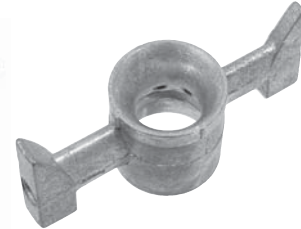

4500 Short Annular Booster
H19-11 Old Style
 (34-9)



Skirted Annular Booster
 Housing
H19-55



4500 Skirted Annular Booster
H19-45 750 HP
 (34-36)



4500 HP Annular Booster Housing
H19-52



Annular Adapter Booster Tool
RT-23

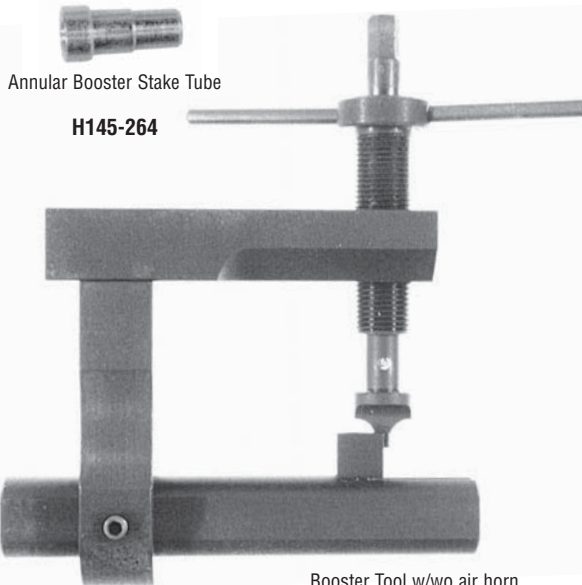

Annular Booster Stake Tube
H145-264

Booster Tool w/wo air horn
RT-24
 Replacement Cutter Tip
RT-35

NOTE: IT IS OUR POLICY NOT TO SELL BOOSTERS TO ANYONE WHO DOES NOT HAVE THE PROPER INSTALLATION TOOLS.

Holley® HIGH PERFORMANCE

CHOKES / COMPONENTS



Choke Housing to Body
Screw
(8-32 x 1¹³/₁₆" L)
H5-81
(1005-569)



Fast Idle Cam Plate Screw
(Manual Choke)
(8-32 x 1¹/₂" L)
H5-83
(1005-623)



Choke Housing to Body Gasket
(Cork)
20-413
(108-67)



Fast Idle Cam
(4180)
{Green}
H17-55
(1041-931)



Fast Idle Cam
(4010/11, 4150)
{Red}
H17-56
(45-376)



Choke Thermostat Gasket
20-2899 Fiber - .040 thk.
20-492 Rubber Bonded Fiber - .050 thk.
20-1433 Fiber - .060 thk.



Choke Thermostat Gasket
20-416 Rubber Bonded Fiber - .030 thk.



Choke Thermostat
(Electric)
H170-113
(45-223, 258)

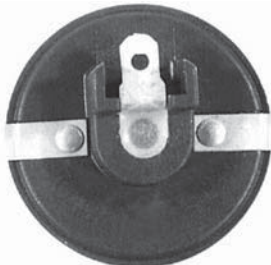

Choke Thermostat
(Electric)
H170-114
(45-230)

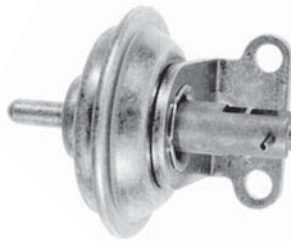

Choke Pull-Off
10-2107
(9-118)



Choke Pull-Off
10-2297
(9-16)

Holley® HIGH PERFORMANCE

CHOKE COMPONENTS



Choke Shaft
(For Screw-In Plate)

H12-64
(1003-278)



Choke Shaft Screw

39-19
(1005-4)



Choke Lever

H14-36
(1004-524)

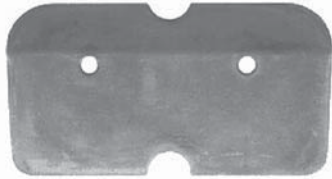

Choke Plate
(2300/4150)

H186-71
(1002-388)

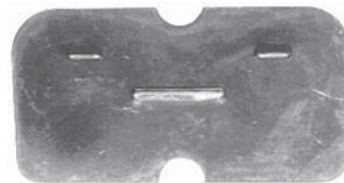

Choke Plate
(List 3310-4, 4779-6)

H186-73
(1002-531)

Holley® HIGH PERFORMANCE

CHOKE CONVERSION KITS

ELECTRIC CHOKE KIT - COMPONENTS SOLD SEPARATELY

LIST 1850, 3310, 6425, 7448

ACE P/N	DESCRIPTION
20-413	Choke Housing to Body Gasket-Cork
20-1433	Choke Cover Gasket
61-185	Rod Retainer
63-244	Thermostat Cap Clamp
H5-81	Choke Housing Screw (3 Req.)
39-134A	Thermostat Cap Clamp Screw (3 Req.)
H5-107	Fast Idle Cam Lever Screw
H17-62	Fast Idle Cam Lever
H25-83	Choke Housing Assembly
H61-252	Fast Idle Cam Lever Adj. Screw Spring
H115-389	Choke Rod
H170-113	Electric Choke Thermostat
H204-25	Wire & Terminal Assembly
N/A	Male Spade Terminal
R146-2	Vacuum Hose-5/32" I.D. (100 ft. roll)

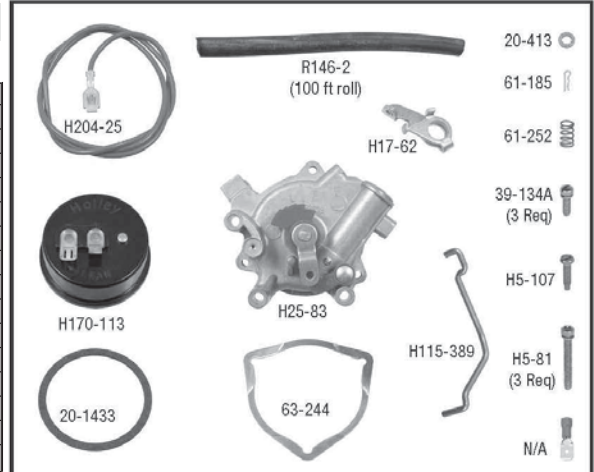

45-223 (Holley Ref # Only)

ELECTRIC CHOKE KIT - COMPONENTS SOLD SEPARATELY

LIST 4412, 4776, 77, 78, 79, 80, 81, 6299, 6708, 6709

ACE P/N	DESCRIPTION
5-246	Passage Plug-Lead Ball
N/A	Vacuum Tee Connector
20-1433	Choke Cover Gasket
61-185	Rod Retainer
63-244	Thermostat Cap Clamp
H5-81	Choke Housing Screw (3 Req.)
39-134A	Thermostat Cap Clamp Screw (3 Req.)
H5-107	Fast Idle Cam Lever Screw
H5-108	Choke Housing Screw
H10-111	Choke Housing Spacer
H17-62	Fast Idle Cam Lever
H25-87	Choke Housing Assembly
H61-252	Fast Idle Cam Lever Adj. Screw Spring
H115-389	Choke Rod
H170-113	Electric Choke Thermostat
H204-25	Wire & Terminal Assembly
N/A	Male Spade Terminal
N/A	Vacuum Hose-1/8" I.D.

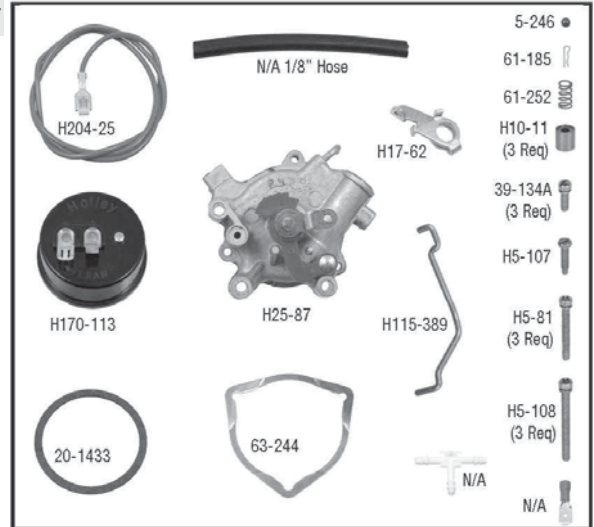

45-224 (Holley Ref # Only)

MANUAL CHOKE KIT - COMPONENTS SOLD SEPARATELY

ALL MODELS: 2300, 4150, 4160

ACE P/N	DESCRIPTION
5-246	Passage Plug-Lead Ball
H2-24	POD Cover Nut
H5-83	Fast Idle Cam Plate Screw (3 Req.)
39-134A	Bracket Clamp Screw
H14-33	Choke Lever and Swivel
H17-60	Fast Idle Cam Lever Assembly
H17-61	Fast Idle Cam P/U Lever
H25-59	Bracket Clamp
H25-60	Choke Control Bracket
H25-88	Back-up Plate Assembly
H25-89	Fast Idle Cam and Plate
H25-90	Choke Wire Bracket
H61-155	Fast Idle Cam Lever Spring
U2-19	Vacuum Cap-5/16"
5-238	Vacuum Cap-1/4"

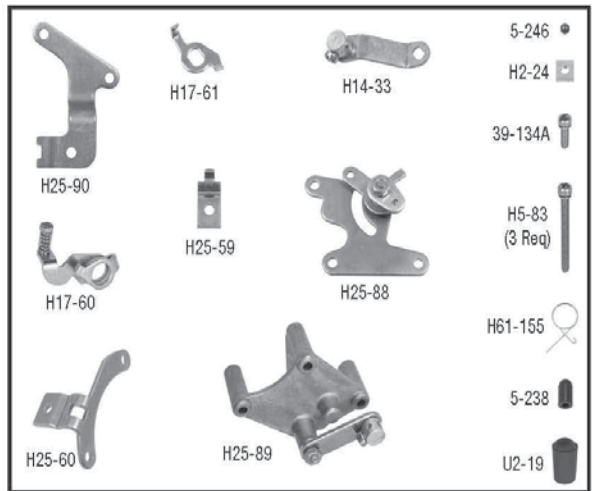

45-225 (Holley Ref # Only)

Holley® HIGH PERFORMANCE

FLOAT BOWLS



Primary Float Bowl
(center hung)
H118-22
(134-103)
H118-35 Dual Inlet
(134-108)



Secondary Float Bowl
(center hung)
H118-23 Model 4160 - Vac Sec
(134-102)
H118-24 Model 4150
(134-104)
H118-36 Dual Inlet
(134-112)



Quick Change Float Bowl
(center hung)
H118-27 Primary
(34-25)
H118-28 Secondary
(34-26)



Primary Float Bowl
(side hung)
H118-29
(134-101)



Secondary Float Bowl
H118-33
(134-105)
H118-34
(134-106)

Holley® HIGH PERFORMANCE

FLOAT BOWL HARDWARE

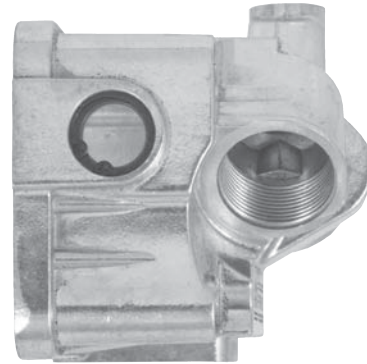
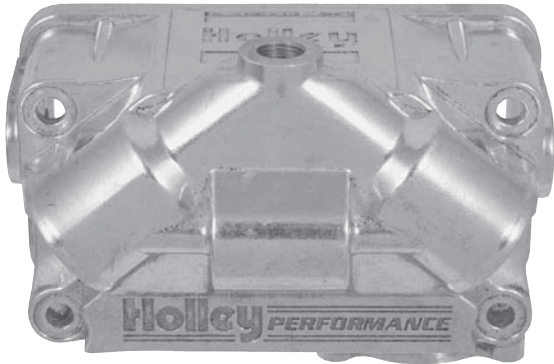

Aluminum V-Bowls w/Clear Sight Glass Installed (center hung)

- H118-44** Secondary (134-715)
- H118-45** Secondary (134-735)
- H118-46** Secondary - Vacuum Model 4160 (134-725)



Fuel Level Sight Plug and Gaskets

- 5-257** Brass Plug (26-13)
- 20-192** Fiber
- 20-607** Copper
- 20-1983** Rubber Coated Aluminum



See-Thru Fuel Level Sight Plug and O-Ring

- H5-91** Plug (26-113)
- 20-337** O-Ring (26-37)



Quick Change Bowl - Jet Plug and Gaskets

- H5-96** (26-85)
- 20-950** Fiber
- H20-27** Rubber Coated Aluminum (108-77)



Aluminum V-Bowl Components

- H201-15** Snap Ring
- H2-27** Sight Glass
- 20-2526** O-Ring



Vent Valve Seal

- H2-11** (1023-556)



Primary Baffle Plate

- H25-108** (1059-96)



Secondary Baffle Plate

- H25-109** (1059-97)



Fuel Bowl Vent Screen

- H30-21** (26-39)



12-24 Helical Thread Repair Kit

- HC11-12** (26-2)



12-24 Helical Insert (Repairs Fuel Bowl Screw Threads)

- HC4-12** (26-3)



N&S Repair Kit (Allows repair of fuel bowl to use O.E. N & S)

- HC11-13**



N&S Threaded Insert (Use Loctite to hold in place)

- HC4-13**

Holley® HIGH PERFORMANCE

FLOAT BOWL HARDWARE



Fuel Bowl Screw
H5-45 2 1/2" L
 (26-6)
H5-46 1 7/8" L
 (26-8)
H5-258 2 5/8" L



Fuel Bowl Screw Gasket
20-1254 Fiber
 (108-2)
20-1662 Rubber Coated
 Aluminum
H108-38 Teflon (reusable)
 (108-98)



Fuel Transfer Tube O-Ring
 (Old Style)
20-337 O-Ring
 (26-37)



Fuel Transfer Tube Seal
 (New Style)
H20-287
 (108-97)

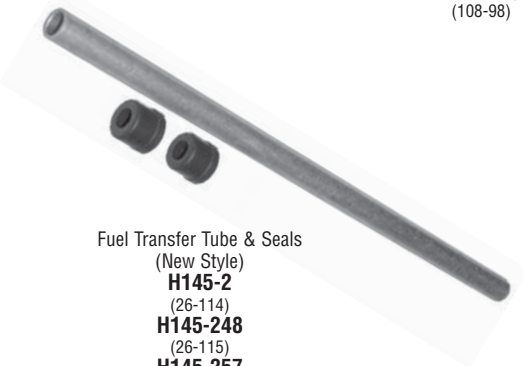

Fuel Transfer Tube & Seals
 (New Style)
H145-2
 (26-114)
H145-248
 (26-115)
H145-257
 (26-116)



Fuel Transfer Tube Only
 (New Style)
H145-269 5 1/2" L
H145-270 6 3/16" L
H145-271 7.00" L



Fuel Inlet Swivel Fitting
 Hose: 5/16"
 9/16-24 Thd.
SP-25
 (26-25)



Fuel Inlet Fitting
 Tube: 3/8"
 7/8-20 O.D. Thd.
H15-86
 (26-26)
H15-90
 (Marine w/screen)



Fuel Inlet Plug
 7/8-20 Thd.
H5-90
 (26-18)



Fuel Inlet Fitting Gasket
 (7/8" I.D.)
20-422 1/64" Fiber
20-1451 1/32" Rubber
 (108-8) Coated Steel
20-2903 3/64" Fiber
R20-35P 1/16" Teflon
 (26-102)



Fuel Inlet Fitting
 Hose: 5/16" Hose: 3/8"
 9/16-24 Thd. 9/16-24 Thd.
H15-88 **H15-89**
 (26-24) (26-29)



Fuel Inlet Fitting
 Tube: 3/8" Tube: 5/16"
 9/16-24 O.D. Thd. 9/16-24 O.D. Thd.
 5/8-18 I.D. Thd. 1/2-20 I.D. Thd.
H15-64 **156-97**
 (26-43) (26-42)



Fuel Inlet Fitting Gasket
 (used on fittings shown at left)
 (9/16" I.D.)
20-75 Fiber
20-676 Rubber Coated
 Aluminum
 (108-11)



Bronze Fuel Inlet Filter
30-32



Fuel Inlet Filter Gasket
 (Used on 30-32)
20-511



Fuel Inlet Filter Spring
61-510

Holley® HIGH PERFORMANCE

FLOATS / COMPONENTS

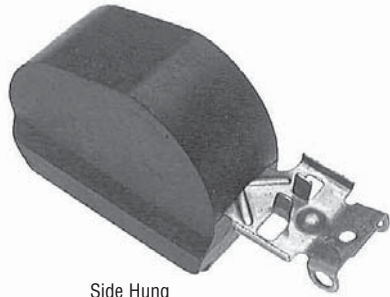

Side Hung
(Nitrophy)
21-726A
(116-1)



Side Hung
(Brass)
21-742A
(116-4)



Center Hung
(Nitrophy)
21-729A
(116-3)

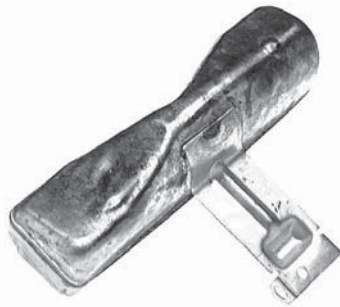

Center Hung
(Brass)
21-756A
(116-2)



Center Hung
(Notched)
H21-31



Float Bracket Screw
(6-32 x 9/16" L)
H5-87
(1005-1016)



Float Pin
H24-50
(1017-41)



Float Bracket
H25-44
(1059-79)
H25-44SS
(Stainless Steel)



Side Hung Float Spring
(primary)
H61-82
(1038-757)



Side Hung Float Spring
(secondary)
H61-152
(1038-803)



Center Hung Float
Bumper Spring
H61-150
(1038-1216)

Holley® HIGH PERFORMANCE

AIR CLEANER / AIR HORN / FUEL BOWL GASKETS

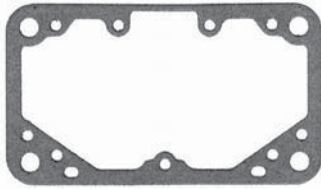

Fuel Bowl Gasket
20-3023 Brown resin
(108-32)
H20-301 Blue O.E. Non-Stick
(108-92)



Fuel Bowl Gasket
(black latex)
20-2255

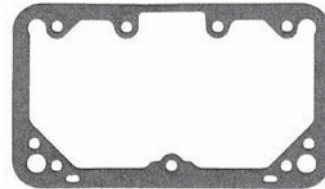

Fuel Bowl Gasket
20-2466 Black latex
20-2926 Brown resin
H20-288 Red Non-Stick
H20-296 Blue O.E. Non-Stick
(108-83)

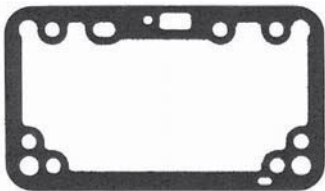

Fuel Bowl Gasket
(4180)
(black latex)
20-2798
(108-56)

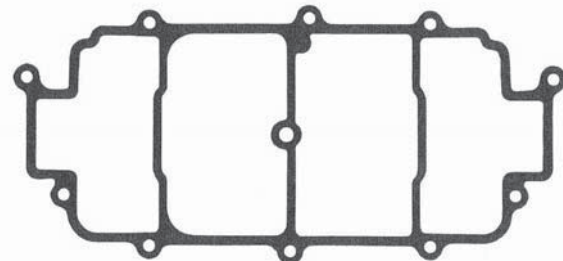

Air Horn Gasket
(model 4010)
20-3277
(108-63)

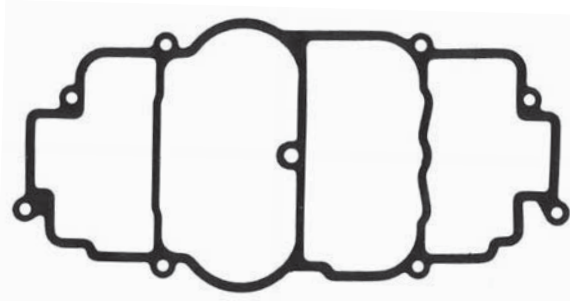

Air Horn Gasket
(model 4011)
20-3278
(108-64)



Air Cleaner Gasket
(tri-power)
H20-265
(108-71)



Air Cleaner Gasket
(5" I.D.)
20-1899 1/16" thk.
(108-4)
20-2910 9/64" thk.



4500 Air Cleaner Gasket
(7" O.D. x 1/16" thk.)
H20-276
(108-73)

Holley® HIGH PERFORMANCE

FLANGE GASKETS



Flange Gasket
(4150/60)
(1¹³/₁₆" bore)
20-1094 (020 thk.)
H20-268 (1/16" thk.)
(108-76)

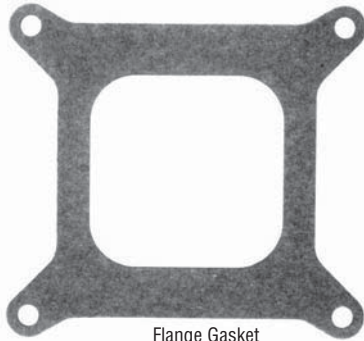

Flange Gasket
(4160)
(1¹¹/₁₆" bore)
20-2257 (3/64" thk.)

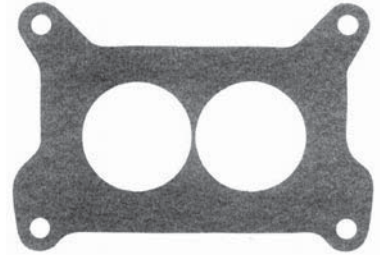

Flange Gasket
(2010/2300)
20-1229 (.060 thk.)
(108-9)

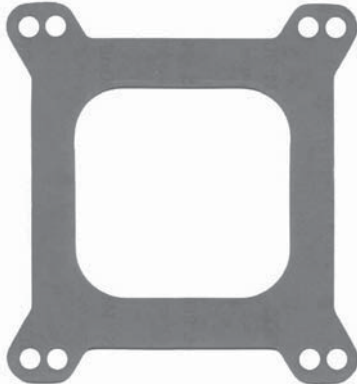

Flange Gasket - Universal
H20-283 (1/16" thk.)
(1 3/4" Bore)

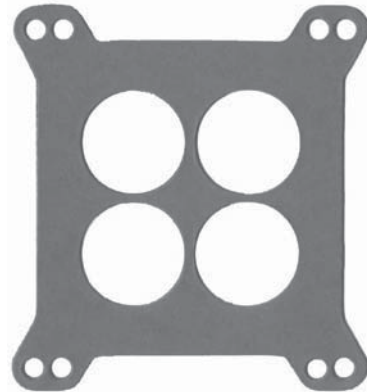

Flange Gasket - Universal
H20-284 (1/16" thk.)
(1 3/4" Bore)



Flange Gasket
(4500 Dominator - 1/16" thk.)
20-1637 (1/16" thk.)
(108-17)

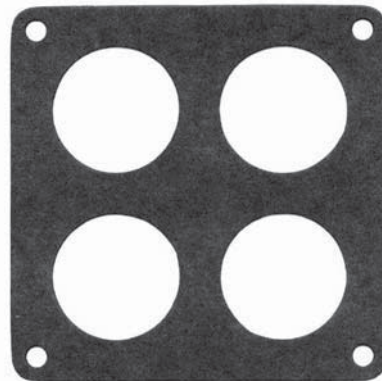

Flange Gasket
(4500 Dominator 1/16" thk.)
20-1638 1050/1150
(1008-1436)
20-1636 1050/1150/1250
(108-99)

Holley® HIGH PERFORMANCE

METERING BLOCK GASKETS

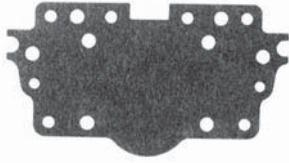

Metering Plate Gasket

20-1417
(108-27)

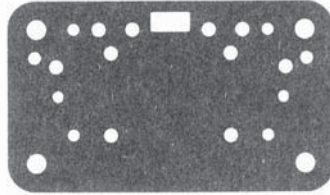

Metering Block Gasket
(black fiber)
20-1423

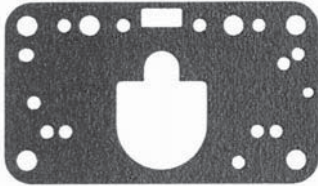

Metering Block Gasket

20-2465 Black Latex
(108-91)

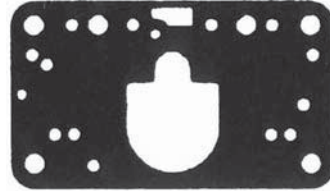

Metering Block Gasket
(black latex)
20-2254
(1008-1848)

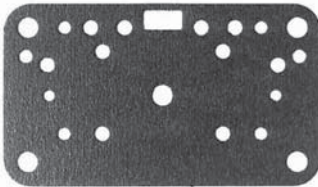

Metering Block Gasket

20-2464 Black Latex
H20-277 Blue O.E. Non-Stick
(108-30)
H20-291 Red Non Stick
(108-90)



Metering Block Gasket
(black latex)
20-2467
(108-55)



Metering Plate Gasket

20-2624
(108-13)

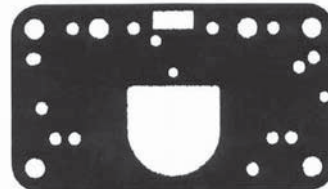

Metering Block Gasket

20-2820 Black Latex
20-2975 Brown Resin

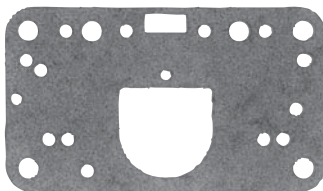

Metering Block Gasket

20-2973 Brown Resin
(108-29)
H20-289 Red Non-Stick
H20-299 Blue O.E. Non-Stick
(108-89)

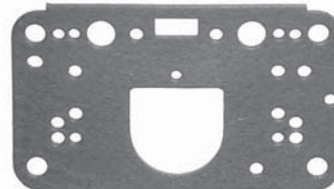

Metering Block Gasket
(4500 HP 3-Circuit)

H20-290 Red Non-Stick
(108-36)
H20-298 Blue O.E. Non-Stick
(108-108)

Holley® HIGH PERFORMANCE

THROTTLE BODY GASKETS

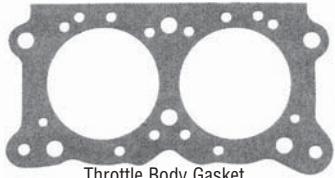

Throttle Body Gasket
(List 7448)
20-1410
H20-285 O.E.
(108-74)



Throttle Body Gasket
(2300)
20-1564
(1008-1265)

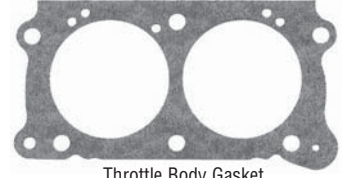

Throttle Body Gasket
(List 4412)
20-2613
H20-286
(108-40)

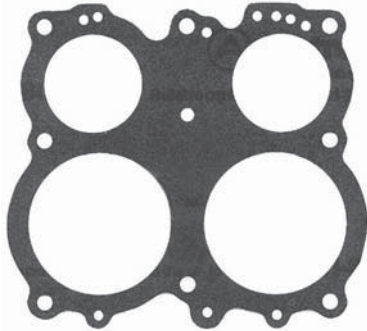

Throttle Body Gasket
(4165/75)
20-1634

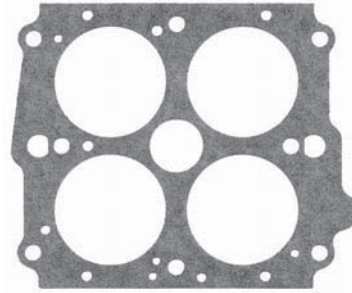

Throttle Body Gasket
(4180)
20-2198
(108-57)

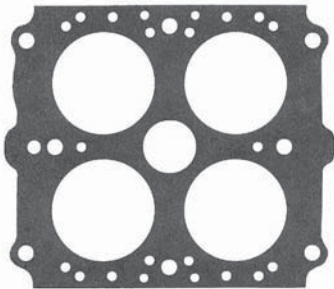

Throttle Body Gasket
(17/16" x 17/16" bore)
20-1639 green fiber
H20-271 black fiber
(108-61)

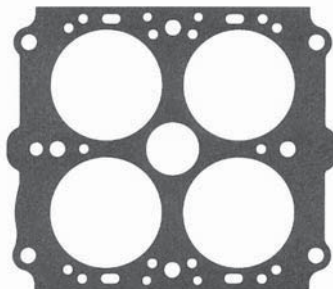

Throttle Body Gasket
(19/16" x 19/16" bore)
20-1640 black fiber (1/32" thk.)
20-1990 black fiber (3/64" thk.)
H20-272 black fiber (1/32" thk.)
(108-3)

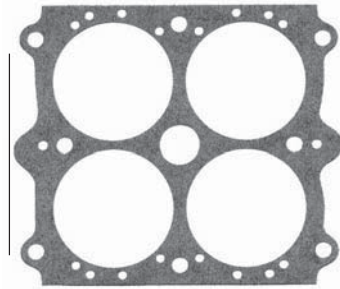

Throttle Body Gasket
(111/16" x 111/16" bore)
20-1095 black fiber
H20-273 black fiber
(108-5)

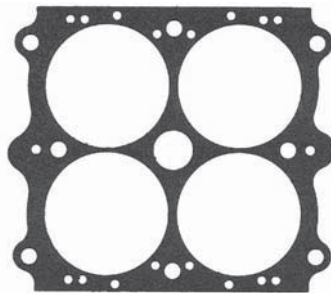

Throttle Body Gasket
(13/4" x 13/4" bore)
(black fiber)
20-1224
(108-7)

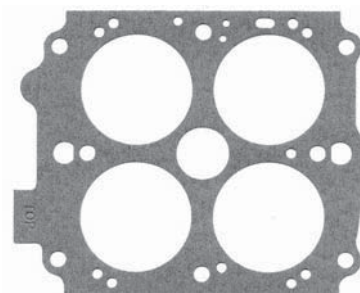

Throttle Body Gasket
(black fiber)
20-2306
(1008-1735)

Holley® HIGH PERFORMANCE

JETS AND BLEEDS



Idle Channel Restrictor
(.110 dia. x .021 orifice)
(drill to size)
H10-104
(1007-654-54)



Press-In Bleed (T-Restrictor)
(.122 dia. x .016 pilot)
(drill to size)
H10-106
(1007-640 series)



Press-In Bleed (T-Restrictor)
(⁵/₃₂" dia. x .046 orifice)
(drill to size)
H10-109
(1007-641 series)



Screw-In Air Bleed
(10-32 thd. w/countersink)
(drill to size)
H10-107



Jet Extension (Screw-In)
(use w/notched float)
H10-110
(P/O 122-5000)



4500 HP Screw-In Air Bleed
(w/.023 hole)
(10-32 thd)
H10-114



Press-In Bleed
(.125 dia. x .020 orifice)
H10-121
(1007-275)



Screw-In Emulsion Jet
(6-32thd x .020 pilot)
(Drill to Size)
H10-122
(142-20)



Jet Removal Tool
RT-25
(26-68)



ACE P/N	O.E. P/N	STAMPED JET #	ORIFICE
H151-60	122-60	60	.060
H151-61	122-61	61	.060
H151-62	122-62	62	.061
H151-63	122-63	63	.062
H151-64	122-64	64	.064
H151-65	122-65	65	.065
H151-66	122-66	66	.066
H151-67	122-67	67	.068
H151-68	122-68	68	.069
H151-69	122-69	69	.070
H151-70	122-70	70	.073
H151-71	122-71	71	.076
H151-72	122-72	72	.079
H151-73	122-73	73	.079
H151-74	122-74	74	.081
H151-75	122-75	75	.082
H151-76	122-76	76	.084
H151-77	122-77	77	.086
H151-78	122-78	78	.089
H151-79	122-79	79	.091

ACE P/N	O.E. P/N	STAMPED JET #	ORIFICE
H151-80	122-80	80	.093
H151-81	122-81	81	.093
H151-82	122-82	82	.093
H151-83	122-83	83	.094
H151-84	122-84	84	.099
H151-85	122-85	85	.100
H151-86	122-86	86	.101
H151-87	122-87	87	.103
H151-88	122-88	88	.104
H151-89	122-89	89	.104
H151-90	122-90	90	.104
H151-91	122-91	91	.105
H151-92	122-92	92	.105
H151-93	122-93	93	.105
H151-94	122-94	94	.108
H151-95	122-95	95	.118
H151-96	122-96	96	.118
H151-97	122-97	97	.125
H151-98	122-98	98	.125
H151-99	122-99	99	.125
H151-100	122-100	100	.128

Holley® HIGH PERFORMANCE

MAIN BODIES

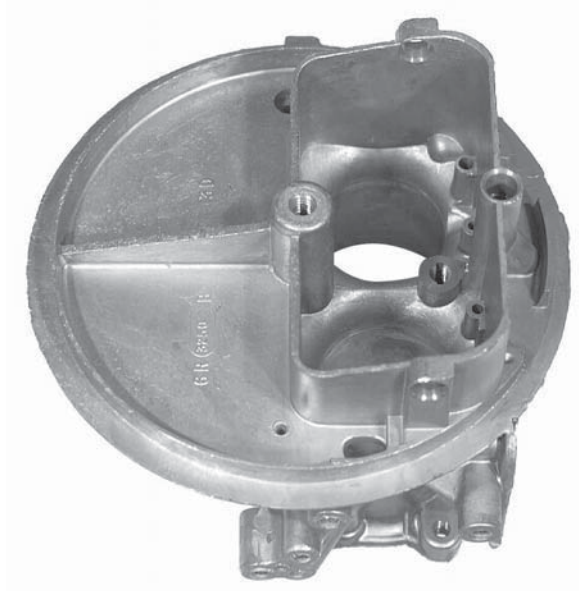

Main Body
{Bare Machined}

H25-94	350 / List 7448
H25-54	500 / List 4412

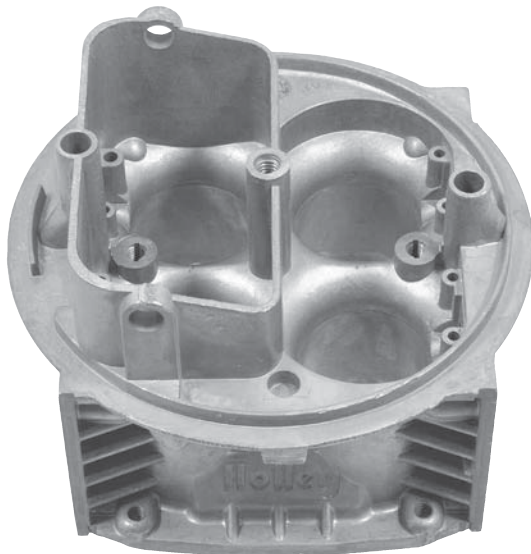

Main Body
{Bare Machined}

H25-98	650 / List 4777
H25-55	750 / List 4779

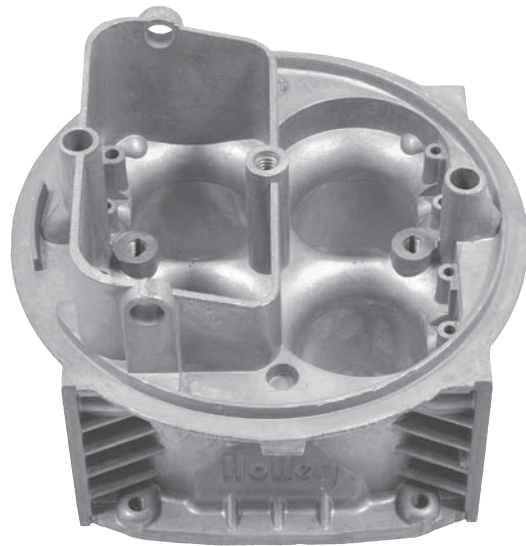

Main Body
(List 4781)
{Bare Machined}

H25-56

Holley® HIGH PERFORMANCE

MAIN BODIES

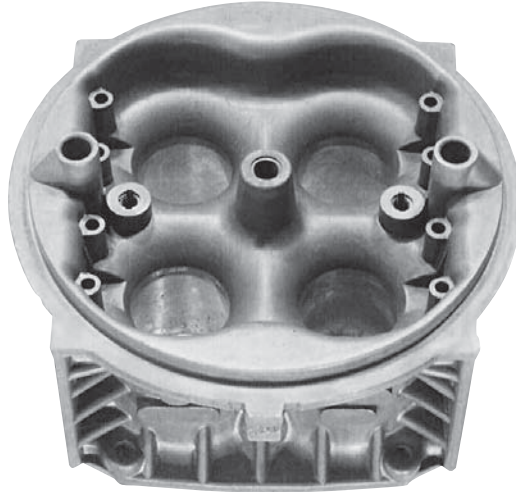

HP Main Body
(Bare Machined)

H25-57	390
H25-93	600
H25-99	650
H25-103	750
H25-81	950
H25-82	1000

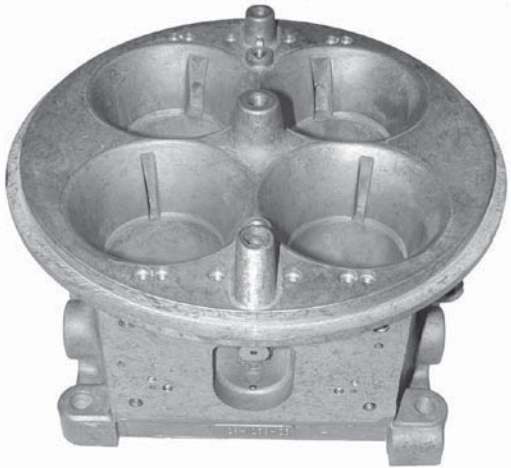

4500 HP Main Body
(Bare Machined)
H25-65 1050

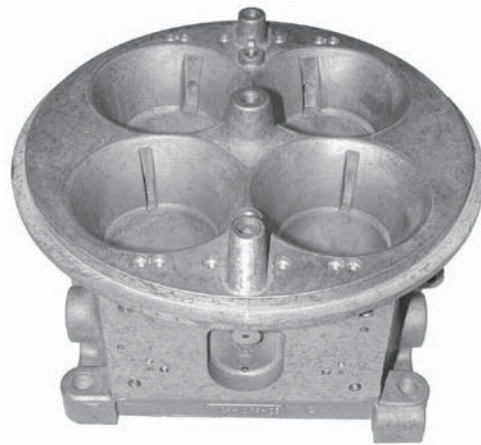

4500 HP Main Body
(Bare Machined)
H25-66 1150
H25-113 1250

Holley® HIGH PERFORMANCE

METERING BLOCKS

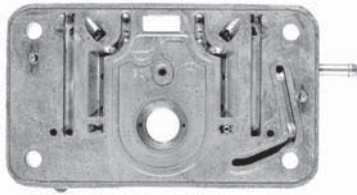

1850 Primary Metering Block
(Complete)
H25-77
(134-128)

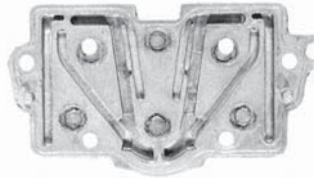

Secondary Metering Plate

H25-75 List 1850
(134-9)
H25-76 List 3310
(134-21)

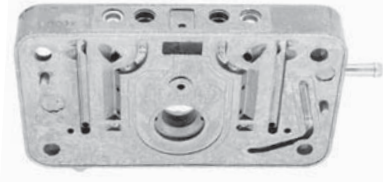

3310 Primary Metering Block
(Complete)
H25-40
(134-131)

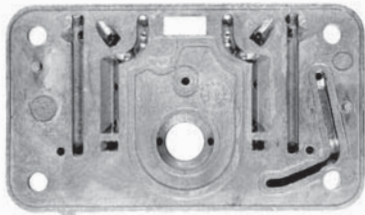

4412 Bare Machined Metering Block

H25-78
(P/O 134-137)

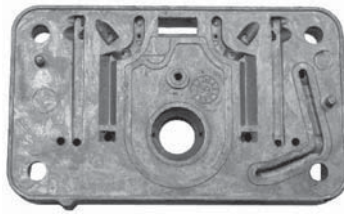

7448 Bare Machined Metering Block
H25-112

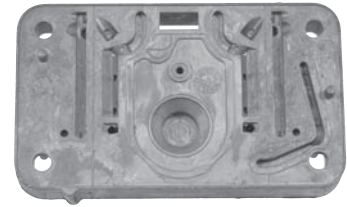

4150 Secondary Bare Machined Metering Block
(2-Corner Idle)
H25-96

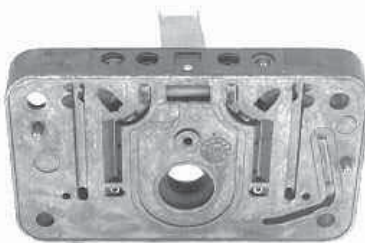

4779 Secondary Metering Block
(4-Corner Idle)

H25-105 (Complete)

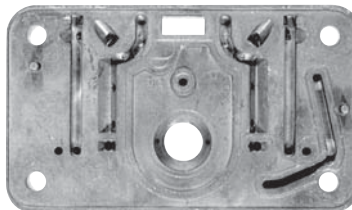

4779 Bare Machined Metering Block
(4-Corner Idle)

H25-74 Bare Machined
H25-79 Complete

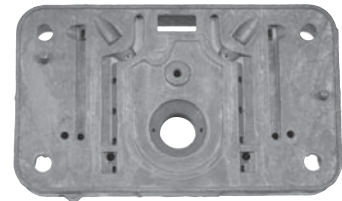

4150 HP Primary and Secondary Bare
Machined Metering Block

H25-50 390
H25-92 750/950
H25-120 830
H25-118 Casting - Unmachined

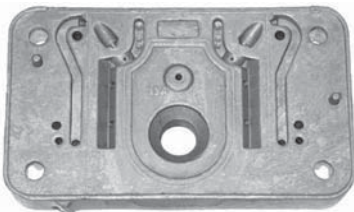

4500 Bare Machined
Metering Block
Old Style
(1050 3-Circuit)

H25-69

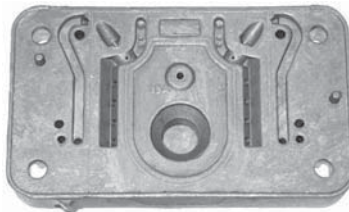

4500 HP Pri/Sec Bare
Machined Metering Block
(1150 3-Circuit)

H25-70

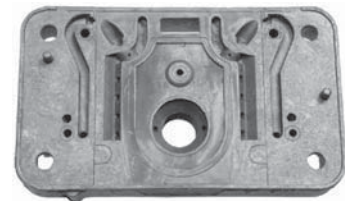

4500 HP Pri/Sec Bare
Machined Metering Block
(3-Circuit)

H25-100 1250
H25-117 1050

Holley® HIGH PERFORMANCE

METERING BLOCK COMPONENTS



Idle Adjusting Screw Seal
(cork)
20-421
H20-292
(26-110)



Idle Mixture Screw
28-37 Brass
H28-111 Steel
(1015-40)



Idle Mixture Screw
H28-110
(1015-120)



Idle Channel Restrictor
(.110 O.D. x .021 orifice)
(drill to size)
H10-104
(1007-654-54)



Press-In Air Bleed
(T-Restrictor)
($\frac{1}{8}$ " O.D. x .016 pilot)
(drill to size)
H10-106
(1007-640 series)



Press-In Air Bleed
(T-Restrictor)
($\frac{5}{32}$ " O.D. x .046 orifice)
(drill to size)
H10-109
(1007-641 series)



Screw-In Emulsion Jet
(6-32 thd x .020 pilot hole)
(Drill to Size)
H10-122
(142-20)



Vent Baffle Drive
Screw
H5-77
(1005-159)



Vent Baffle
H25-42
(1059-37)



Vent Baffle
H25-101 4500 HP
(1059-171)



1/4" Brass
Well Plug
5-231 thick wall
5-146 thin wall
(1007-107)



Accelerator Pump
Passage Plug
(.132)
H47-47
(1007-129)



Well Plug
(.192)
H47-48
(1007-20)



Well Plug
(.156)
5-232
(1007-122)



Metering Plate Screw
H5-109
(1005-691)



Tube
($\frac{3}{16}$ " O.D. x 1.00 L)
H145-254



4500 Idle Well Tube
H145-260
(1014-744-70)



Emulsion Tube
(List 7448)
H145-267
(1014-782A)



4500 HP Idle Well Tube
H145-268
(1014-1293A)



Metering Plate
Back-Up Plate
H186-75

Holley® HIGH PERFORMANCE

NEEDLE AND SEAT / COMPONENTS



Needle & Seat Gasket
(Small)
20-529 Fiber
(1008-777)
H20-303 Nylon



Needle & Seat Gasket
(Large)
20-528 Fiber
(1008-776)
H20-302 Nylon



Needle & Seat
Lock Screw
39-168
(1005-765)



Needle & Seat
Adjusting Nut
105-20
(1039-160)



N & S Repair Kit
(Allows repair of Fuel Bowl
to Use O.E. N&S)
HC11-13



N & S Threaded Inserts
(Use Loctite to hold in
place)
HC4-13



Needle & Seat Assembly
(Viton)
25-463A STD.
(.101)
25-463AX O.S. thread
(.120)
25-634A 4165/75
(.120)



Needle & Seat Assembly
(Viton)
{Model 4165/75}
25-611A (.110)
(1018-252)



Needle & Seat
Assembly
(Viton)
25-976A (.097)
H25-63 (.097)
(6-506)
25-990A (.110)
H25-64 (.110)
(6-504)
H25-80 (.120)
(6-518)
H25-127 (.130)



Needle & Seat
Assembly
(Steel)
H25-34 (.110)
(6-500)
H25-36 (.120)
(6-502)
H25-37 (.130)
(6-515)
H25-38 (.150)
(6-519)

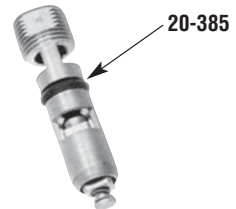

Needle & Seat
Assembly
(spring loaded - off-road)
H25-39 (.097)
(6-513)

Holley® HIGH PERFORMANCE

POWER VALVES / COMPONENTS



ACE P/N	HOLLEY P/N	OPENING
H160-25	125-25	2.5" Hg
H160-35	125-35	3.5" Hg
H160-45	125-45	4.5" Hg
H160-50	125-50	5.0" Hg
H160-55	125-55	5.5" Hg
H160-65	125-65	6.5" Hg
H160-75	125-75	7.5" Hg
H160-85	125-85	8.5" Hg
H160-95	125-95	9.5" Hg
H160-145 (Alcohol)	125-145	4.5" Hg
H160-165 (Alcohol)	125-165	6.5" Hg

ACE P/N	HOLLEY P/N	OPENING
8-144A	125-25	2.5" Hg
8-145A	125-35	3.5" Hg
8-146A	125-45	4.5" Hg
N/A	125-50	5.0" Hg
8-147A	125-55	5.5" Hg
8-149A	125-65	6.5" Hg
8-148A	125-75	7.5" Hg
8-150A	125-85	8.5" Hg
8-159A	125-95	9.5" Hg
8-151A	125-105	10.5" Hg

Use Power Valve Gaskets 20-2305
O.E. VERSION POWER VALVES

Use Power Valve Gaskets 20-2053
ACE VERSION POWER VALVES

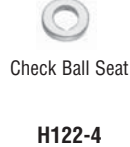

(Above components are used in the Holley 125-500 Power Valve Blow-out Protection Kit)
(NOTE: Install only on Holley Models 2300, 4150, 4160, 4165 and 4175)



Holley® HIGH PERFORMANCE

SECONDARY DIAPHRAGMS / COMPONENTS



Diaphragm Housing
to Body Screw
(8-32 x 1.00 L)
H5-80
(26-66)



Diaphragm Housing
Cover Screws
(8-32 x 5/8" L)
H5-101
(26-65)



Secondary Diaphragm
Lever Screw
(10-32 x 5/16" L)
H5-82
(1005-584)



Secondary Diaphragm
Link Retainer
[holds stem to
lever assembly]
63-99
(1036-164)



Secondary Diaphragm
Lever Assembly
H63-60
(20-87)



Diaphragm Housing
H25-58
(20-86)



Diaphragm Housing
Cover
H2-25
(20-85)



Housing Gasket - Cork
20-413
(108-67)



Secondary Diaphragm
64-315A (1 7/8" L)
(135-2)
64-600A (1 31/32" L)
(135-3)
64-744A (2 1/16" L)
(18-9 & 135-4)

[Stem length is measured from
base of stem to center of hole]



Secondary Diaphragm
64-707A
(1035-747)

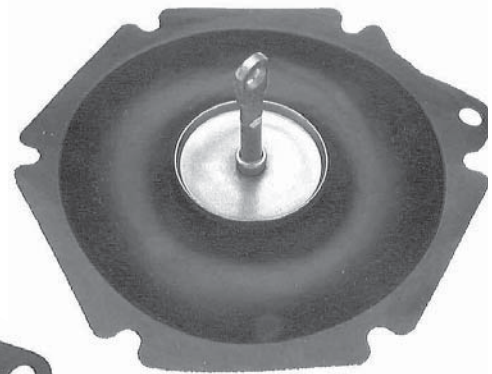

Secondary Diaphragm (Tri-Power)
H64-13
(135-6)

Holley® HIGH PERFORMANCE

SECONDARY DIAPHRAGM COMPONENTS



61-604



61-608



61-609



61-606



61-605



61-607

ACE P/N	COLOR	LOAD
61-605	White	Lightest
61-604	Short Yellow	Lighter
61-608	Long Yellow	Light
61-609	Purple	Medium Light
61-606	Plain	Medium
61-607	Brown	Medium Heavy
61-610	Black	Heavy



61-610



Choke Control Wire Bracket

H25-60



Choke Control Wire Bracket Clamp

H25-59



Choke Control Wire Bracket Clamp Screw
(8-32 x 1/2" L)
39-134A



Choke Control Wire Bracket Clamp Screw Nut
(8-32)
H2-24

(Above parts are used in P/N 45-456, Clamp Kit – Choke Control Cable.)
{For manual chokes. Required to convert plastic secondary diaphragm cover to metal}

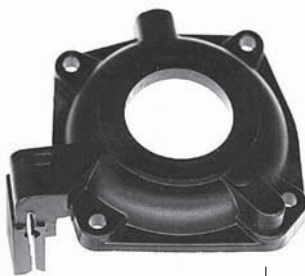

Secondary Diaphragm Cover - Quick Change

H118-30



Secondary Diaphragm Cover Retainer - Quick Change

H150-78



Secondary Diaphragm Cover Retainer O-ring fits between H118-30 and H150-78

H20-278



Secondary Diaphragm Housing Mounting Gasket – cork

20-413
(108-67)



Screw **39-134A**
(8-32 x 1/2" L)
Nut **H2-24**
(8-32)
Washer **H108-40**
(.185 I.D. x .550 O.D.)

(Above parts are used in P/N 20-59 Quick Change Secondary Diaphragm Housing Cover)
{Allows quick exchange of vacuum springs}

Holley® HIGH PERFORMANCE

THROTTLE SHAFTS

Primary Throttle Shaft

H3-49 4150 models
H3-52 List 3310



Primary Throttle Shaft
[w/ Ford A/T
Kickdown Lever]

H3-55 List 3310
List 1850
(P/O 20-48-1)
(P/O 20-49-1)

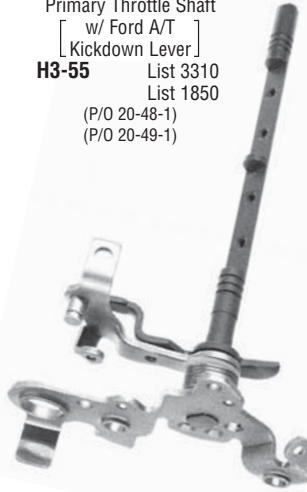

Primary Throttle Shaft
(1:1 Linkage)

H3-56
(P/O 20-3)



Pri/Sec Throttle Shaft
(4500 HP)
H3-64



Throttle Shaft
(List 4412)
H3-65



Secondary Throttle Shaft
(4150 Models)
H3-50



Secondary Throttle Shaft
(List 1850, 3310)
H3-53



Secondary Throttle Shaft
(use w/ H3-56, 57)
H3-58
(P/O 20-3, 27)



Throttle Lever -
Marine Weld-On
H22-71



Racing Throttle Lever -
Weld On
(Plain Steel)
H22-72



Holley® HIGH PERFORMANCE

THROTTLE SHAFT COMPONENTS



Throttle Shaft
Bushings - Teflon
(.015 thk. x 1/4" W x 1 1/8" L)
36-33
(1013-490)



Throttle Shaft
Bushings - Teflon
(.022 thk x .120 W x 1 1/8" L)
36-34
(1013-590)



Throttle Shaft
Bushings - Teflon
(.360 I.D. x .500 O.D. x 400 L)
36-35
(1013-599)



Throttle Shaft
Bushings - Teflon
(.022 thk. x 1/4" W x 1 1/8" L)
36-36
(1013-600)



Throttle Shaft
Bushings - Teflon
(.015 thk. x .113 W x 1 1/8" L)
H10-47
(1013-513)



Fast Idle Cam Lever -
Sec. Pump Cam
Lever Screw
(8-32 x 5/16" L)
H5-82
(1005-584)



4500 Throttle
Lever Screw
(fits: H3-46, 47, 48)
H5-103
(1005-1258)



4500 Linkage Pivot
Screw / Washer
H5-111 HP Screw
(1005-2043)



4500 Linkage Guide Bushing
H10-115 HP Style
(1013-1469)



4500 Primary
Throttle Lever
(Soft Progressive)
H3-48
(20-20)



4500 Intermediate
Throttle Lever
H63-65 HP Style
(1011-2583)



4500 Secondary Throttle
Lever & Bushing Assembly
H63-62
(1011-1413)



Fast Idle Cam Lever
H17-60
(1004-1287)



Fast Idle Cam P/U Lever
H17-61
(1004-485)



Fast Idle Cam Lever Spring
(use w/ H17-60,61)
H61-155
(1038-583)



Secondary Throttle Shaft
Spring
H61-154
(1038-1762)



4500 Primary Throttle
Shaft Spring
H61-157
(1038-1500)

Holley® HIGH PERFORMANCE

THROTTLE LINKAGE / COMPONENTS



E-Clip Retainer
(use on H5-64)
63-97
(1075-37)



Cam Follower / Accel
Pump Arm Stud
H5-64
(1037-133)



Connecting
Rod Pin
150-31
(1048-183)



Connecting Rod
Washer
H108-39
(1046-395)



Vacuum Secondary
Connecting Rod
(model 4160/4010)
H115-253
(20-53)



Vacuum Secondary
Connecting Rod
(model 4150)
H115-254
(20-65)



Throttle Lever
Connecting Link
(model 4500)
H115-374
(1033-538)



Choke Diaphragm Link
(model 4165/75)
H115-375
(1033-545)



Choke Rod
(model 4150)
H115-377
(1043-252)



Vacuum Secondary
Connecting Rod
(model 4175/4011)
H115-382
(20-55)



Mechanical Secondary
Connecting Rod
(model 4150/4010)
H115-383
(20-54)



Secondary
Connecting Rod
H115-386
(1043-983)



Choke Rod
Converts Mechanical
To Electric Choke
H115-389



Secondary
Connecting Rod
(1:1 Link)
H115-397

Holley® HIGH PERFORMANCE

MISCELLANEOUS



4500 Throttle Shaft
Dust Cover

H2-26
(1007-38)



Screw-In Air Bleed
(10-32 thd. w/countersink)
(drill to size)

H10-107



1/4" Brass Well Plug

5-231 thick wall
5-146 thin wall
(1007-107)



3/8" Well Plug

H47-46
(1007-556)



Accelerator Pump
Passage Plug

H47-47
(1007-129)



Well Plug

(.192)
H47-48
(1007-20)



4500 Idle Trans Plug

(.180)
H47-45
(1007-557)



4500 Idle Passage Plug

(.125)
H47-50
(1007-23)



Aluminum Bowl Vent Tube
(5/16" O.D. x 1 3/8" L)

145-18



Bowl Vent Tube
(5/16" O.D. x .712 L)

H145-261

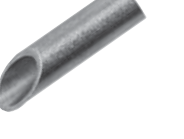

Bowl Vent Tube
(5/16" O.D. x 1.320 L)

H145-262

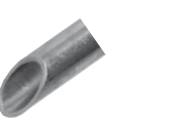

4500 Bowl Vent Tube
(5/16" O.D. x 1.145 L)

H145-263



4500 Bowl Vent Tube
(5/16" O.D. x 1.385 L)

H145-265



J-Tube
(Marine)

H145-252



4500 Aspirator Tube

H145-259 Old Style
(1014-797)
H145-266 New Style HP
(1014-1289)

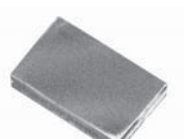

Choke Rod Hole Block-off Plate

H186-69
(1007-435)

Holley® HIGH PERFORMANCE

MISCELLANEOUS



H24-57
H24-58

Roll Pin
(1/8" dia. X 1/2"L)
(1/8" dia. X 7/16"L)



External Hitchpin Clip
(Offset Head)
(.026 wire dia. x 5/16"L)
61-9



External Hitchpin Clip
(.028 wire dia. x 5/16"L)
61-501



Hitchpin Clip
(.042 wire dia. x 7/16"L)
61-185



Cotter Clip
150-31 .047 dia x 1.2"L
150-82 .054 dia x 1.2"L



Vacuum Cap

U2-18 3/16"
5-243 11/64"
5-238 1/4"
U2-19 5/16"
5-239 11/32"
U2-21 3/8"



Vacuum Hose
R146-2 5/32" I.D.
(100 ft. roll)



Bronze Filter
30-32